

**D009NG**

# D010NG

SeaSources.net

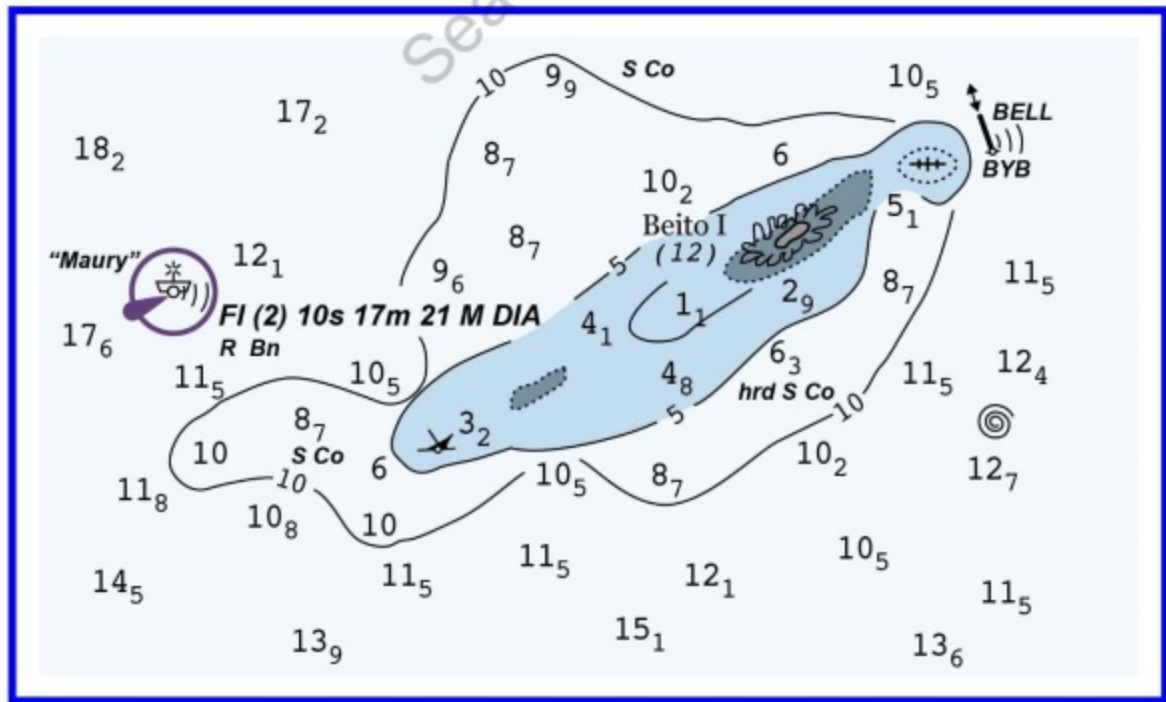

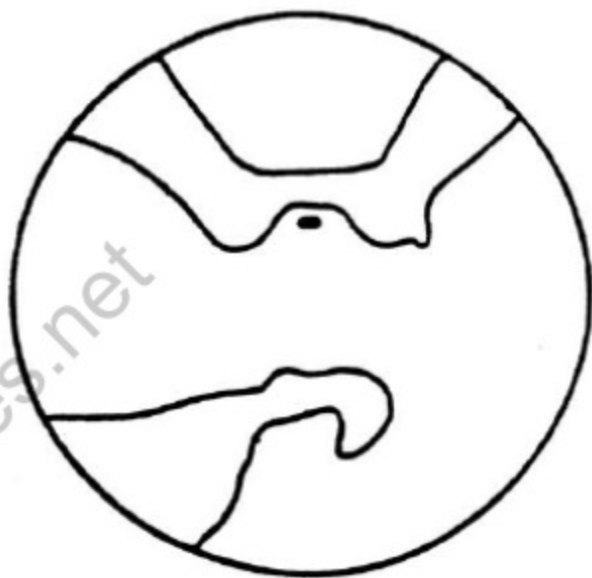
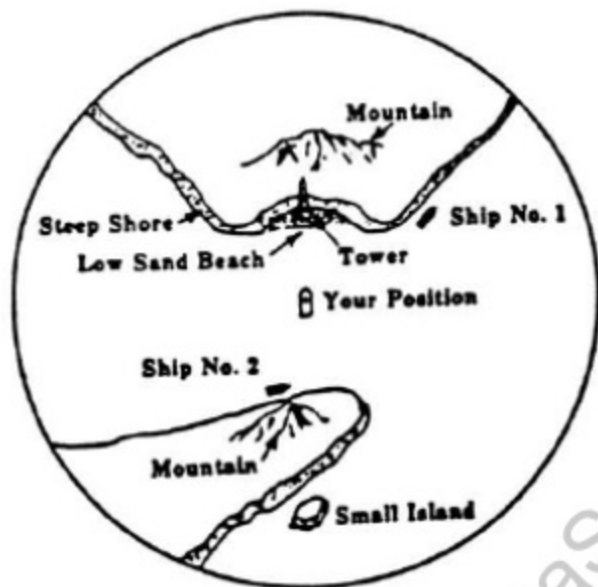





**D011NG**



**D013NG**



**D014NG**

- A.  Fl (2)
- B.  Occ
- C.  L Fl 10s
- D.  Morse "A"

D019NG

## IALA MARITIME BUOYAGE SYSTEM REGIONS A AND B

### SAFE WATER MARKS

Topmark (if any):  
Single sphere.

Shape: Spherical  
or  
pillar or spar.

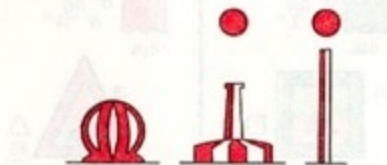

Light, when fitted,  
is **white**  
Isophase or Occulting,  
or one Long Flash  
every 10 seconds or  
Morse "A".

 Iso

 Occ

 L Fl 10s

 Morse "A"

SeaSources.net

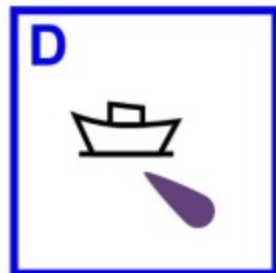
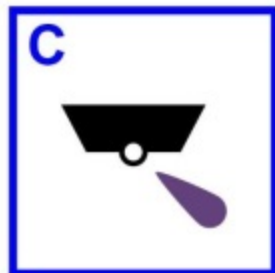
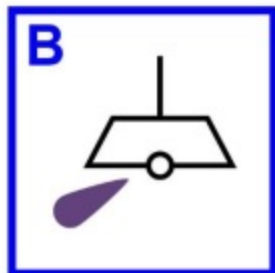



A

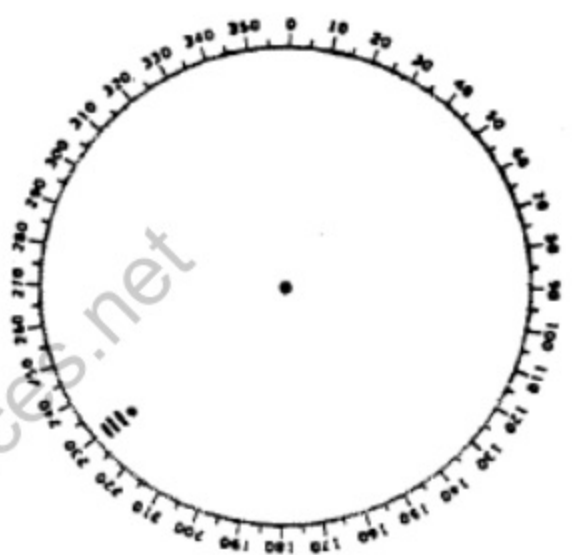

B

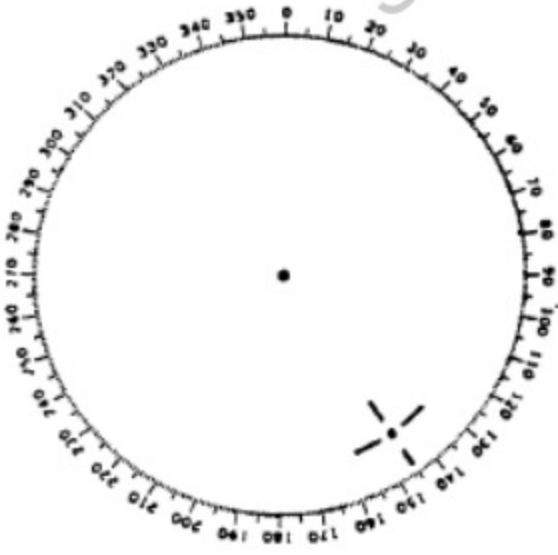

C



D

D017NG





SeaSources.net

**D018NG**

**A**



FI (2)

**B**



Occ

**C**



L FI 10s

**D**



Morse "A"

D020NG



D021NG



D022NG

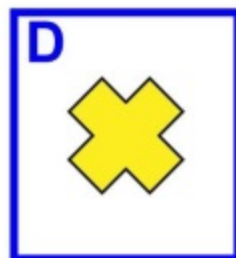
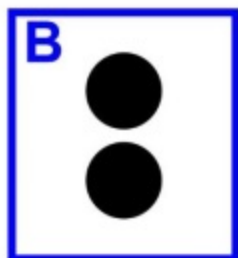
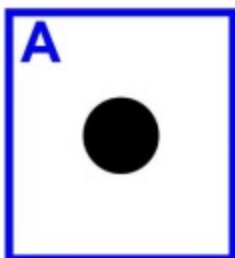

SeaSources.net

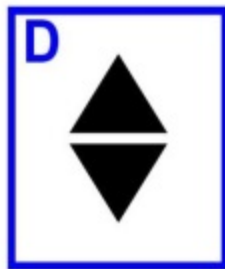
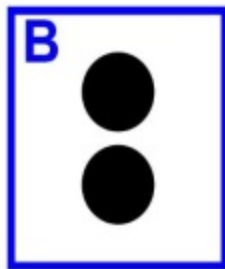
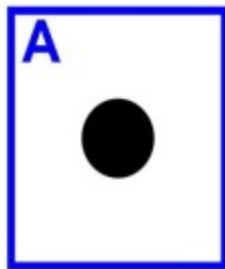



SeaSources.net

**D024NG**



**D025NG**

SeaSources.net



**D026NG**



**D027NG**

SeaSources.net



Q (3) 10s



**D028NG**

SeaSources.net



**D030NG**

SeaSources.net

D031NG

SeaSources.net

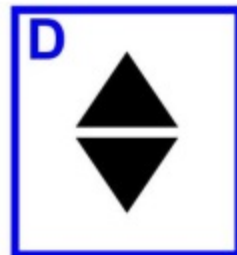
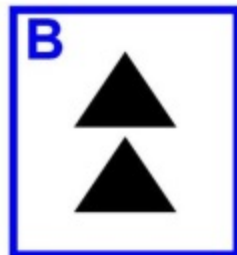

A.  SW

B.  BW

C.  RW

D.  RW

**D032NG**



RW

"A"

**D033NG**

SeaSources.net

D034NG





D036NG

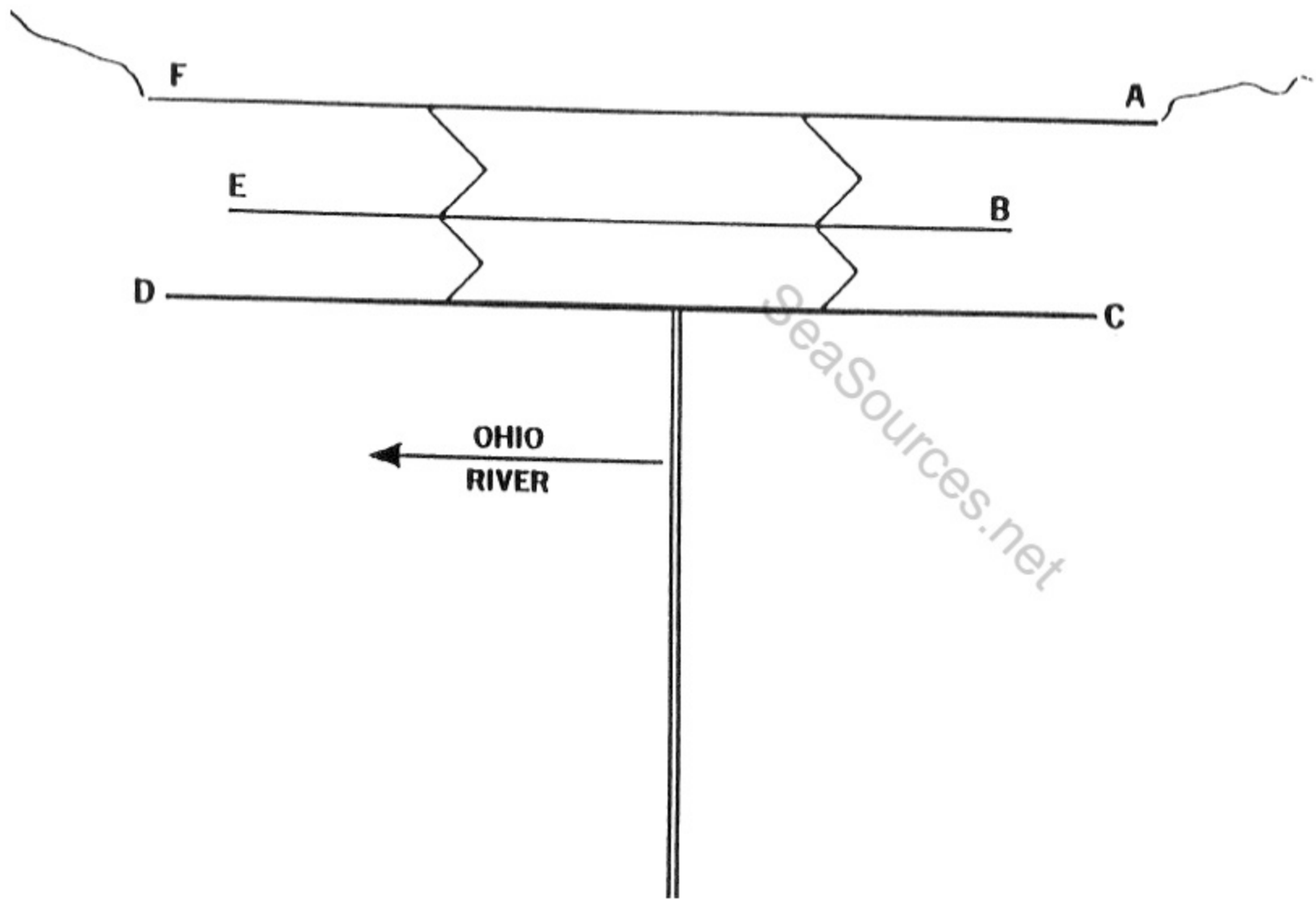

SeaSources.net

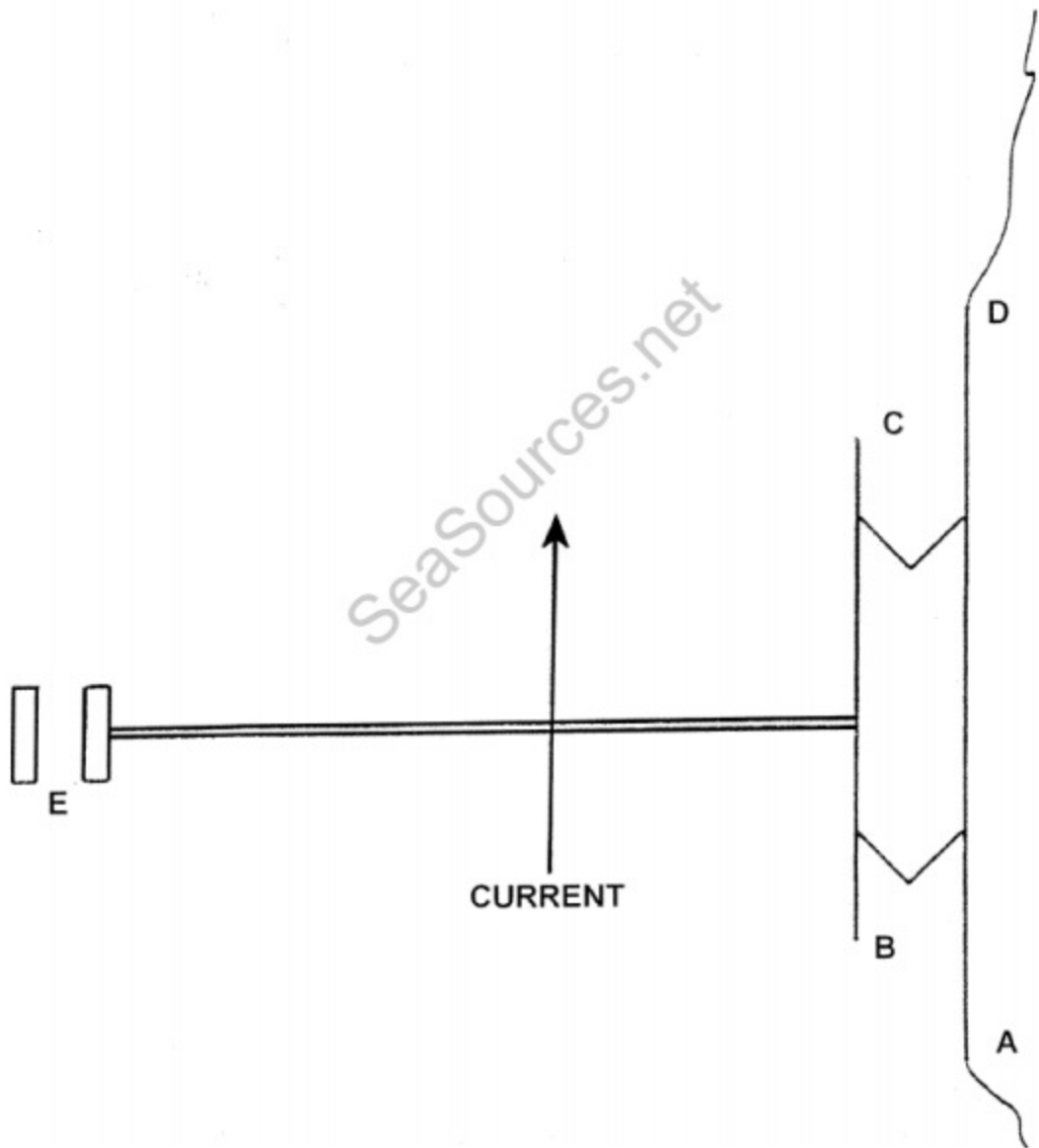

D037NG

Altitude (in feet)

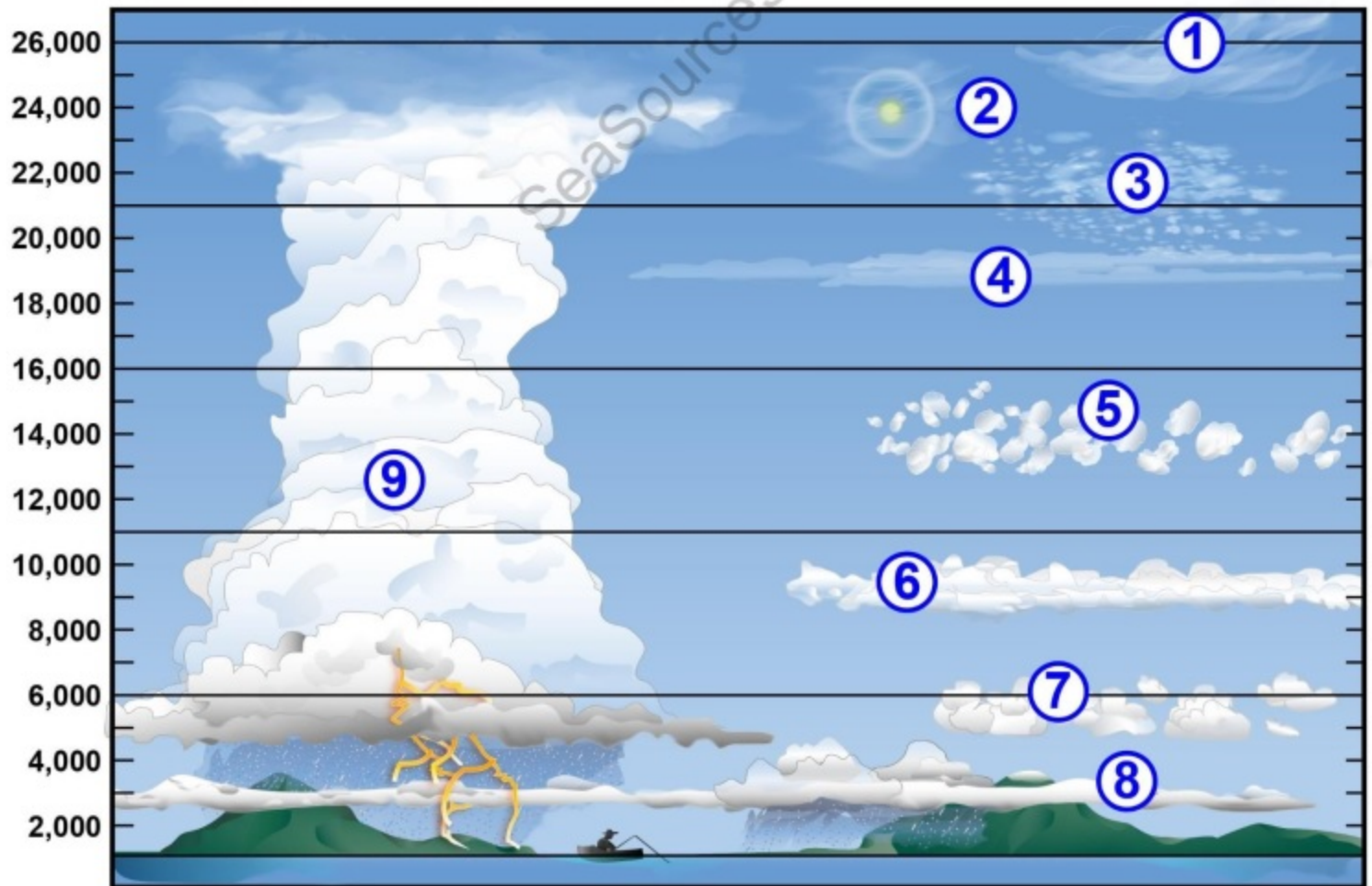

WS FORM B-80 (5-94)  
PRES. BY WMO DIRECTIVES



**U.S. DEPARTMENT OF COMMERCE**  
NATIONAL OCEANIC AND ATMOSPHERIC ADMINISTRATION  
NATIONAL WEATHER SERVICE

## WEATHER REPORT FOR IMMEDIATE TRANSMISSION

NO.	SHIP NAME	DATE SENT (UTC)	TIME SENT (UTC)	STA. CALLED	FREQUENCY

### ADDRESSES

U.S. Coast Guard: No address needed, start with BBXX indicator and ship's call sign.

#### INMARSAT

Standard A: Select—Coast Earth Station (CES), routine priority, duplex telex channel, and initiate call. When GA + is received, select 41 +. Upon receipt of answerback, NWS OBS MHTS, send the weather report starting with the BBXX indicator and ship's call sign. End the report with 5 periods. Try to limit INMARSAT call time to 30 seconds.

Standard C: To establish special access code 41, see manufacturers recommended instructions for set-up, or the Mariners Weather Log Summer, 1994, or later editions.

U.S. commercial and foreign radio stations: To: OBS METEO \_\_\_\_\_  
(get address from "Radio Stations Accepting. . . ."). Start with BBXX indicator and ship's call sign and combine the remaining numbers into 10-character groups.

INDICATOR	CALL SIGN	YYGGi <sub>w</sub>	99L <sub>a</sub> L <sub>a</sub> L <sub>a</sub>	Q <sub>c</sub> L <sub>o</sub> L <sub>o</sub> L <sub>o</sub> L <sub>o</sub>	i <sub>ri</sub> z <sub>h</sub> VV	Nddff
<b>BBXX</b>			<b>99</b>		<b>4</b>	
00fff	1s <sub>n</sub> TTT	2s <sub>n</sub> T <sub>d</sub> T <sub>d</sub> T <sub>d</sub>	4PPPP	5appp	7wwW <sub>1</sub> W <sub>2</sub>	8N <sub>n</sub> C <sub>L</sub> C <sub>M</sub> C <sub>H</sub>
222D <sub>s</sub> V <sub>s</sub>	0s <sub>s</sub> T <sub>w</sub> T <sub>w</sub> T <sub>w</sub>	2P <sub>w</sub> P <sub>w</sub> H <sub>w</sub> H <sub>w</sub>	3d <sub>w1</sub> d <sub>w1</sub> d <sub>w2</sub> d <sub>w2</sub>	4P <sub>w1</sub> P <sub>w1</sub> H <sub>w1</sub> H <sub>w1</sub>	5P <sub>w2</sub> P <sub>w2</sub> H <sub>w2</sub> H <sub>w2</sub>	6I <sub>s</sub> E <sub>s</sub> E <sub>s</sub> R <sub>s</sub>
8S <sub>w</sub> T <sub>b</sub> T <sub>b</sub> T <sub>b</sub>	ICE	c <sub>i</sub> S <sub>b</sub> b <sub>i</sub> D <sub>i</sub> z <sub>i</sub>	PLAIN LANGUAGE			TRANSMITTED BY

No Government Administration, or Company or person employed in the forwarding and delivery of this message shall be liable for any loss or damage arising from failure to transmit or to deliver the said message or from any neglect, delay, error or omission in the transmission thereof.

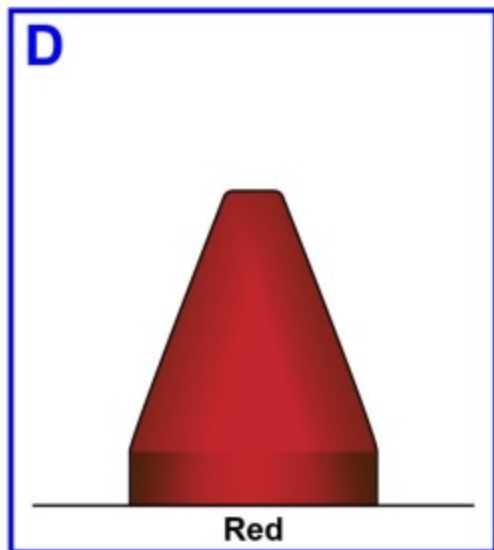
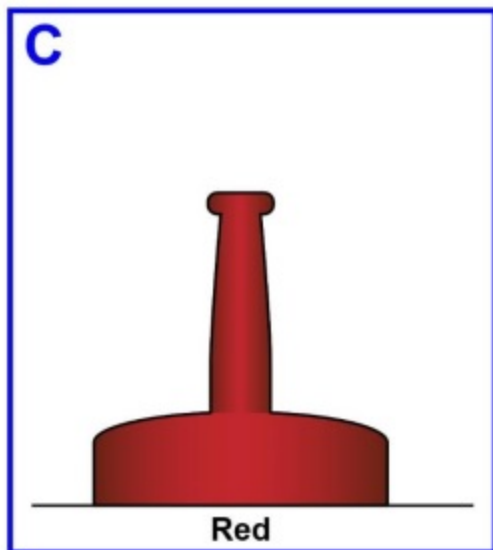
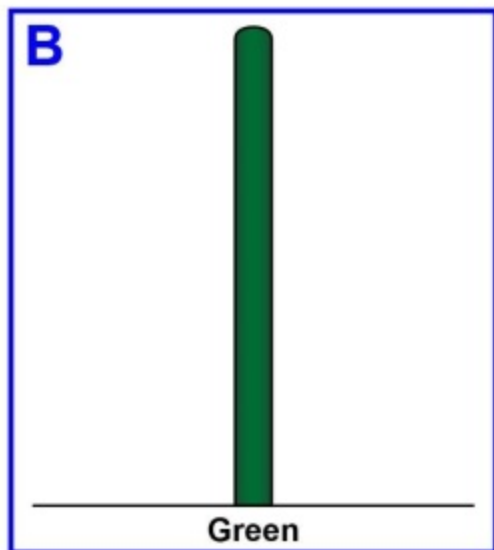
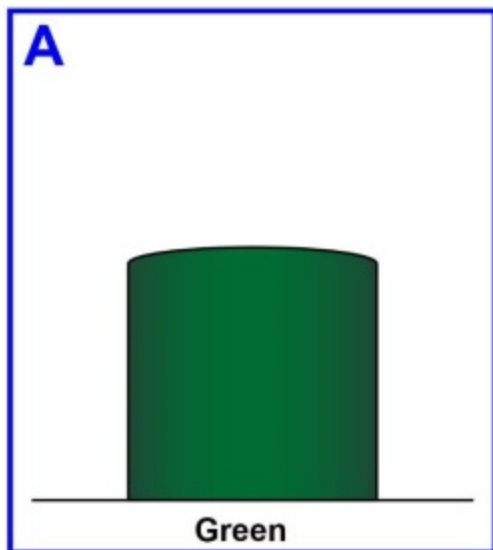

D045NG

A



B

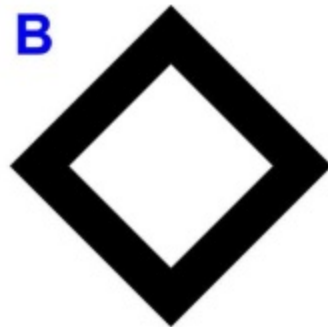

C



D



# D046NG

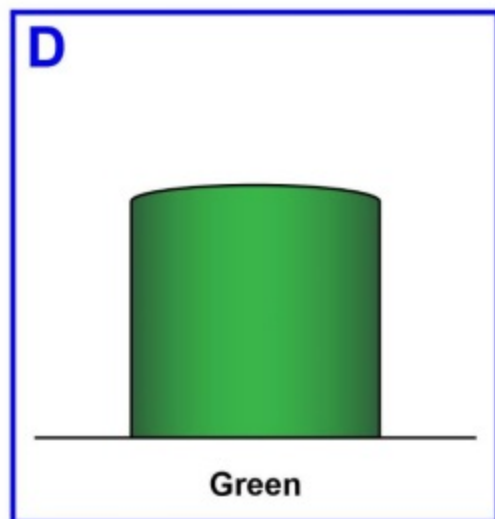
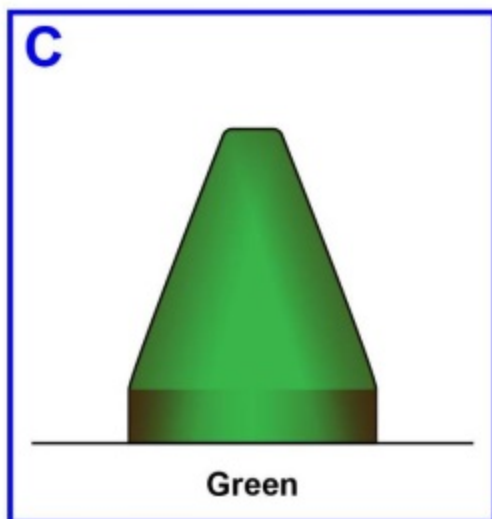
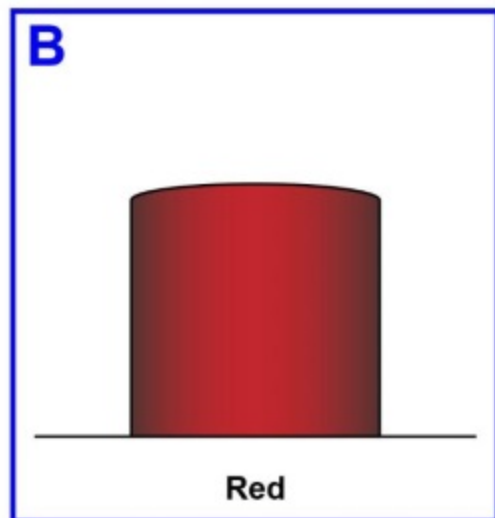
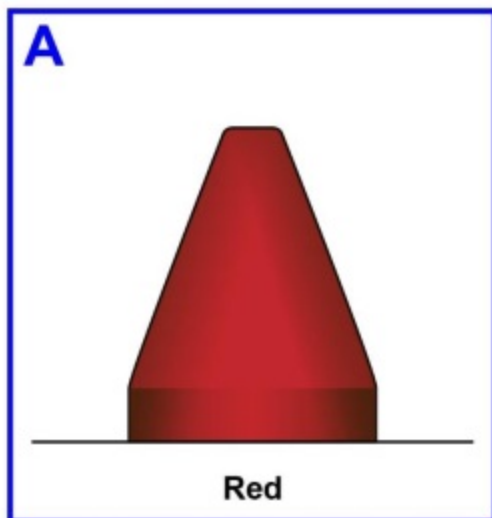

D047NG

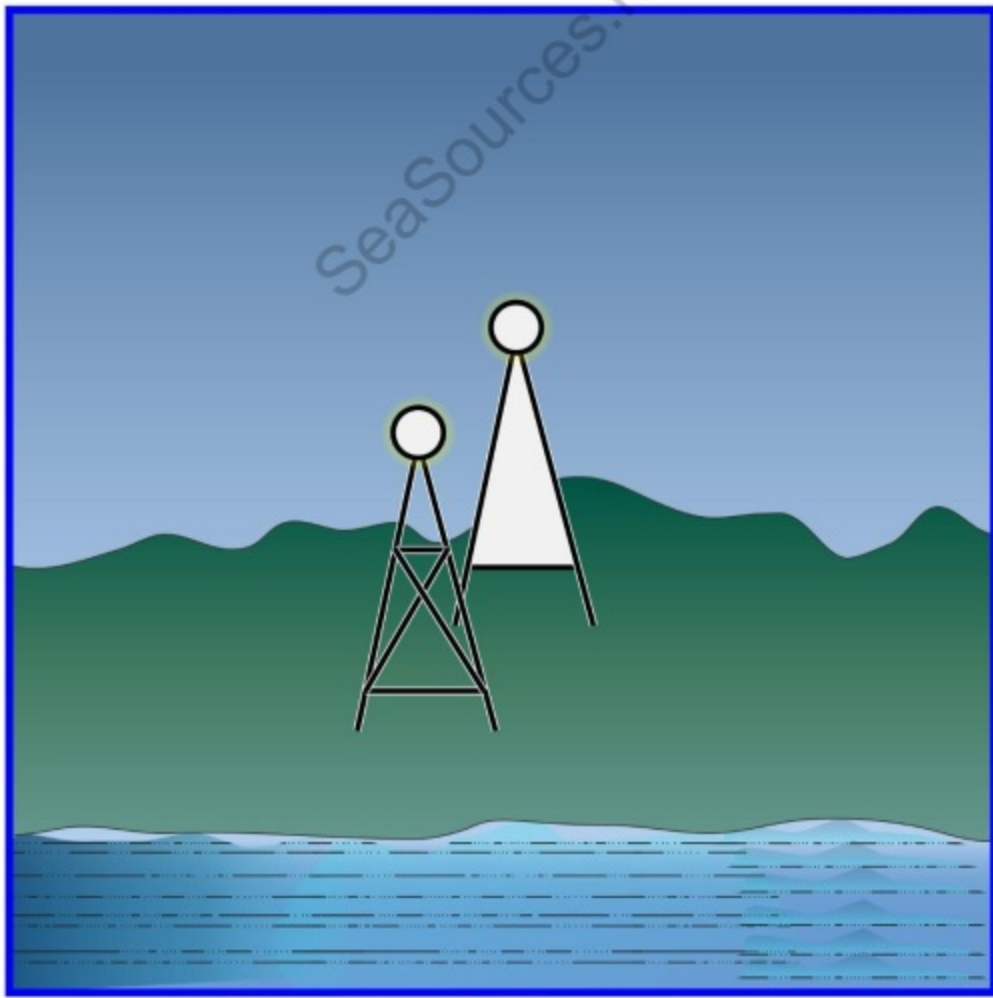



D048NG

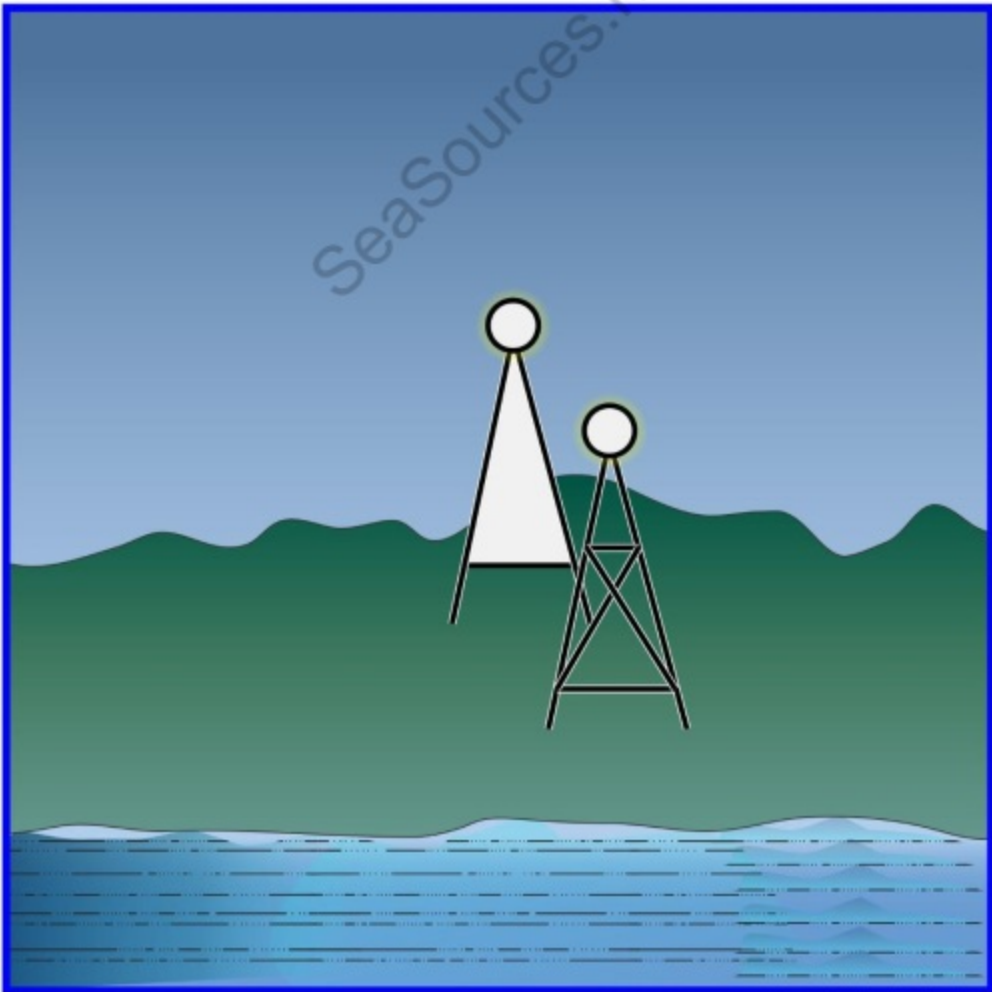

# D049NG

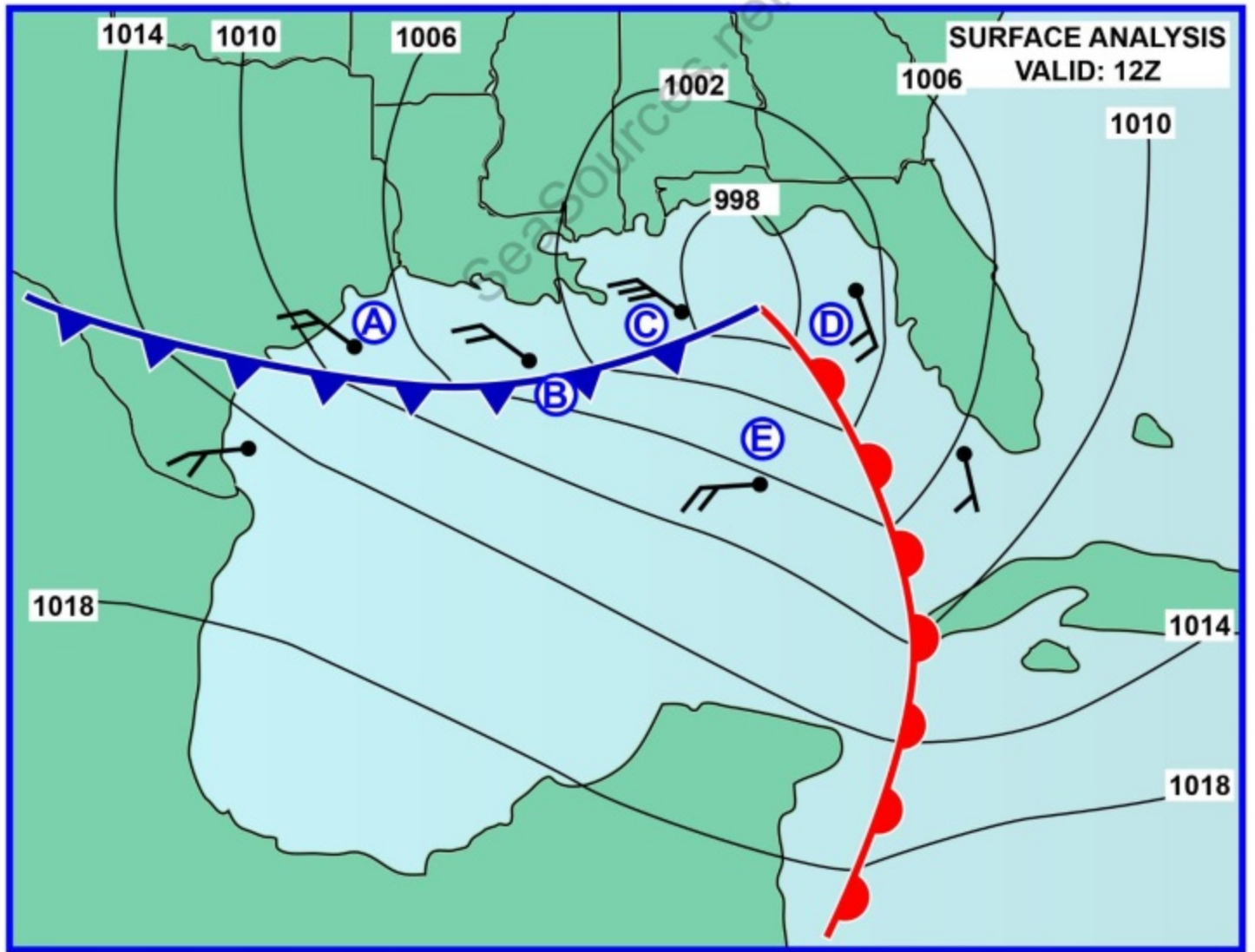

# D051NG

